

Portable Infrared Thermometer

PIR - 550

Temperature : -60 to 550°C



GASDNA Co.,Ltd 101, Bukhang-ro 193beon-gil, Seo-gu, Incheon, 22856, Republic of Korea
Tell: +82-32-584-7420 Fax: +82-32-584-7424 E-mail: sales@gasdna.com Web: www.gasdna.com

<http://www.gasdna.com>

PIR550 Operating Instructions

The thermometer is a non-contact infrared thermometer. There are many mathematical modes for the Infrared function. Please remember to keep away from children and don't use it for safety related applications

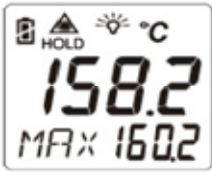

(Default Screen)

Simply aim the thermometer at the measure target with Lens (9) and press Meas. Key (7) to display the surface temperature. The Distance:Spot is 12:1. Please make sure the target area is within the field of view.

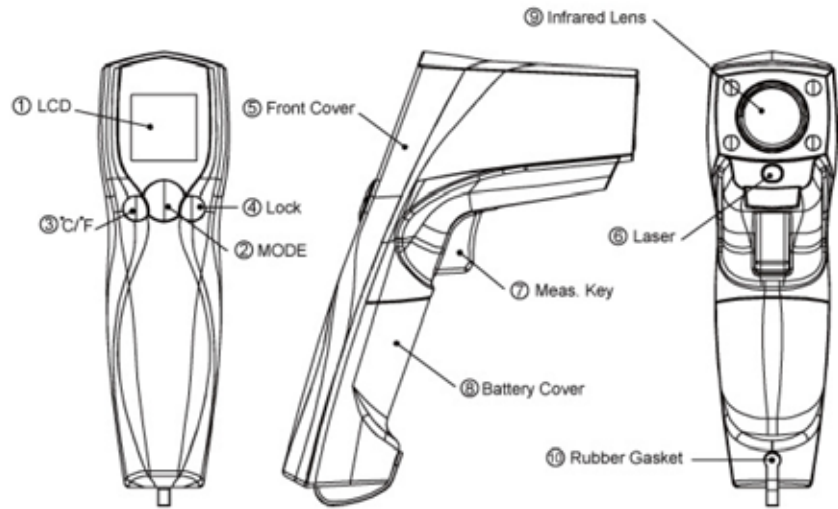

Function

Press Mode key (2) for scrolling more display function as follows.



Here will show the emissivity data. (The default emissivity is 0.95)
Press Mode key (2), then press Lock key (4) or °C / °F key (3) to set the emissivity, then press Mode key (2) to confirm it. The emissivity can be changed from 0.10 (10E) to 1 (100E).
Press Mode key (2) for the Maximum (MAX), Minimum (MIN), Different between MAX and MIN (DIF) and Average (AVG) modes. During the measurement, the special modes reading will be displayed beside the mode icon.
Press Lock key (4) or °C / °F key (3) to change the High Alarm (HAL) or Low Alarm (LAL) , then press Meas. key (7) to confirm it. When the reading is outside the High Alarm (HAL) or Low Alarm (LAL) limit. The High or Low icon will flash and you will hear a beep sound.

ADD VALUE

In E, MAX, MIN, DIF, AVG mode:	Press Lock key (4) for LOCK mode ON/OFF. The lock mode is particularly useful for continuous monitoring of temperatures for up to 60 minutes.
	Press °C / °F key (3) for °C or °F transferred
In all modes: First hold on the Meas. key (7)	and press Lock key (4) for backlight function ON/OFF.
	and press °C / °F key (3) for laser function ON/OFF.
Memory	Memory Recall the last reading memory by pressing Mode key (2) while power off.

CAUTION





1. WHEN DEVICE IS IN USE, DO NOT LOOK DIRECTLY INTO THE LASER BEAM—PERMANENT EYE DAMAGE MAY RESULT.
2. USE EXTREME CAUTION WHEN OPERATING THE LASER.
3. NEVER POINT THE DEVICE TOWARDS ANYONE'S EYES.
4. KEEP OUT OF REACH OF ALL CHILDREN

STORAGE & CLEANING

It should be stored at room temperature. The sensor lens is the most delicate part of the thermometer. The lens should be kept clean at all times, care should be taken when cleaning the lens using only a soft cloth or cotton swab with water or medical alcohol, allowing the lens to fully dry before using the thermometer. Do not submerge any part of the thermometer.

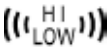

LCD ERROR MESSAGES

The thermometer incorporates visual diagnostic messages as follows:

-  'Hi' or 'Lo' is displayed when the temperature being measured is outside of the settings of HAL and LAL.
-  'Er2' is displayed when the thermometer is exposed to rapid changes in the ambient temperature. 'Er3' is displayed when the ambient temperature exceeds 0C (32°F) or +50C (122°F). The thermometer should be allowed plenty of time (minimum 30 minutes) to stabilize to the working/room temperature.
- 
-  Error 5~9, for all other error messages it is necessary to reset the thermometer. To reset it, turn the instrument off, remove the battery and wait for a minimum of one minute, reinsert the battery and turn on. If the error message remains, please contact the Service Department for further assistance

BATTERIES

The thermometer incorporates visual low battery indication as follows:

		
'Battery OK': measurements are possible	'Battery Low': battery needs to be replaced, measurements are still possible	'Battery Exhausted': measurements are not possible

BATTERY REPLACEMENT

1. Pull out the rubber gasket (10)
2. Loosen the screw and pull out the battery cover
3. Replace and reinstall with new batteries
4. Place the battery cover back and fasten the screw
5. Plug the rubber gasket (10) to avoid failure of water proof

 When the 'Low Battery' icon indicates the battery is low, the battery should be replaced immediately with AAA, 1.5V batteries. Please note: It is important to turn the instrument off before replacing the battery otherwise the thermometer may malfunction

 Dispose of used battery promptly and keep away from children

SPECIFICATION

Measurement Range	-60 to 550 °C (-76 to +1022 °F)
Operating Range	0 ~ 50C (32~ 122 °F)
Accuracy	Measured value ±2% or ±2°C
Emissivity	0.1 ~ 1.0 (default value: 0.95)
Response Time	1 sec
D:S (Distance:Spot)	12:1
Battery Life	min 14 hours continuous use
Dimensions	143.9 x 116.73 x 42.78mm
Weight	180 grams(6.35 oz) including batteries (AAA*2pcs)

Note: Under the electromagnetic field of 3V/m from 200 to 700 MHz, the maximum error is 5C (9°F). The thermometer will automatically shut off if left idle for more than 15sec.

 **EMC/RFI:** Readings may be affected if the unit is operated within radio frequency electromagnetic field strength of approximately 3 volts per meter, but the performance of the instrument will not be permanently affected.